

2N4856A/4857A/4858A

N-Channel JFETs

Product Summary

Part Number	$V_{GS(off)}$ (V)	$V_{(BR)GSS}$ Min (V)	I_{DSS} Min (mA)	$r_{DS(on)}$ Max (Ω)	$I_{D(off)}$ Typ (pA)	t_{ON} Typ (ns)
2N4856A	-4 to -10	-40	50	25	5	4
2N4857A	-2 to -6	-40	20	40	5	4
2N4858A	-0.8 to -4	-40	8	60	5	4

Features

- Low On-Resistance: 2N4856A <25 Ω
- Fast Switching— t_{ON} : 4 ns
- High Off-Isolation— $I_{D(off)}$: 5 pA
- Low Capacitance: 3 pF
- Low Insertion Loss

Benefits

- Low Error Voltage
- High-Speed Analog Circuit Performance
- Negligible “Off-Error,” Excellent Accuracy
- Good Frequency Response
- Eliminates Additional Buffering

Applications

- Analog Switches
- Choppers
- Sample-and-Hold
- Normally “On” Switches
- Current Limiters

Description

The 2N4856A/4857A/4858A all-purpose JFET analog switches offer low on-resistance, low capacitance, good isolation, and fast switching.

Hermetically-sealed TO-206AA (TO-18) packaging allows full military processing (see Military Information). For similar products in TO-226AA (TO-92) and SOT-23 packages, see the J/SST111 series data sheet. For similar duals, see the 2N5564/5565/5566 data sheet.

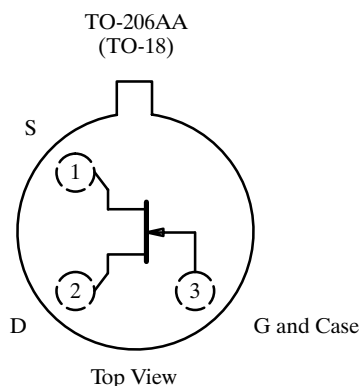

Absolute Maximum Ratings

Gate-Drain, Gate-Source Voltage : (2N4856A-58A)	-40 V	Operating Junction Temperature	-55 to 200°C
Gate Current	50 mA	Power Dissipation ^a	1.8 W
Lead Temperature (¹ / ₁₆ " from case for 10 seconds)	300 °C	Notes	
Storage Temperature	-65 to 200°C	a. Derate 10 mW/°C for $T_C > 25^\circ\text{C}$	

Updates to this data sheet may be obtained via facsimile by calling Siliconix FaxBack, 1-408-970-5600. Please request FaxBack document #70243.

2N4856A/4857A/4858A

Specifications^a

Parameter	Symbol	Test Conditions	Typ ^b	Limits						Unit	
				2N4856A		2N4857A		2N4858A			
				Min	Max	Min	Max	Min	Max		
Static											
Gate-Source Breakdown Voltage	$V_{(BR)GSS}$	$I_G = -1 \mu A, V_{DS} = 0 V$	-55	-40		-40		-40		V	
Gate-Source Cutoff Voltage	$V_{GS(off)}$	$V_{DS} = 15 V, I_D = 0.5 nA$		-4	-10	-2	-6	-0.8	-4		
Saturation Drain Current ^c	I_{DSS}	$V_{DS} = 15 V, V_{GS} = 0 V$		50		20	100	8	80	mA	
Gate Reverse Current	I_{GSS}	$V_{GS} = -20 V, V_{DS} = 0 V$		-5		-250		-250		-250	pA
			$T_A = 150^\circ C$	-13		-500		-500		-500	nA
Gate Operating Current ^d	I_G	$V_{DG} = 15 V, I_D = 10 mA$	-5							pA	
Drain Cutoff Current	$I_{D(off)}$	$V_{DS} = 15 V, V_{GS} = -10 V$		5		250		250		250	nA
			$T_A = 150^\circ C$	13		500		500		500	nA
Drain-Source On-Voltage	$V_{DS(on)}$	$V_{GS} = 0 V$		$I_D = 5 mA$	0.25					0.5	V
				$I_D = 10 mA$	0.35			0.5			
				$I_D = 20 mA$	0.5		0.75				
Drain-Source On-Resistance ^d	$r_{DS(on)}$	$V_{GS} = 0 V, I_D = 1 mA$			25		40		60	Ω	
Gate-Source Forward Voltage ^d	$V_{GS(F)}$	$I_G = 1 mA, V_{DS} = 0 V$	0.7							V	
Dynamic											
Common-Source Forward Transconductance ^d	g_{fs}	$V_{DS} = 20 V, I_D = 1 mA$ $f = 1 kHz$	6							mS	
Common-Source Output Conductance ^d	g_{os}		25							μS	
Drain-Source On-Resistance	$r_{ds(on)}$	$V_{GS} = 0 V, I_D = 0 mA$ $f = 1 kHz$			25		40		60	Ω	
Common-Source Input Capacitance	C_{iss}	$V_{DS} = 0 V, V_{GS} = -10 V$ $f = 1 MHz$	7		10		10		10	pF	
Common-Source Reverse Transfer Capacitance	C_{rss}		3		4		3.5		3.5		
Equivalent Input Noise Voltage ^d	\bar{e}_n	$V_{DS} = 10 V, I_D = 10 mA$ $f = 1 kHz$	3							nV/\sqrt{Hz}	
Switching											
Turn-On Time	$t_{d(on)}$	$V_{DD} = 10 V, V_{GSH} = 0 V$ See Switching Circuit	2		5		6		8	ns	
	t_r		2		3		4		8		
Turn-Off Time	t_{OFF}		12		20		40		80		

Notes

- $T_A = 25^\circ C$ unless otherwise noted.
- Typical values are for DESIGN AID ONLY, not guaranteed nor subject to production testing.
- Pulse test: $PW \leq 100 \mu s$ duty cycle $\leq 10\%$.
- This parameter not registered with JEDEC.

NCB

Typical Characteristics

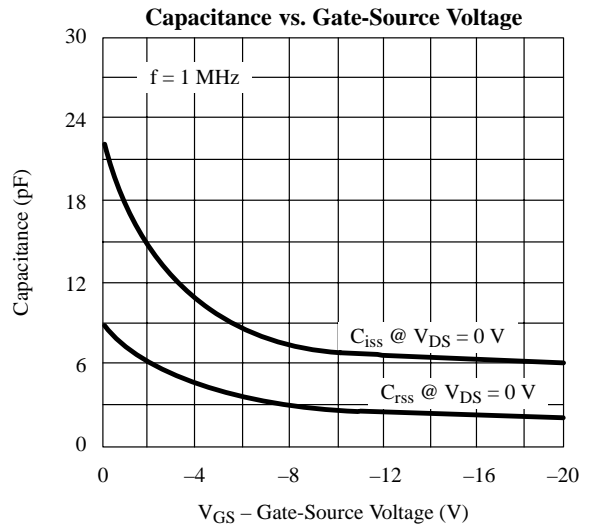
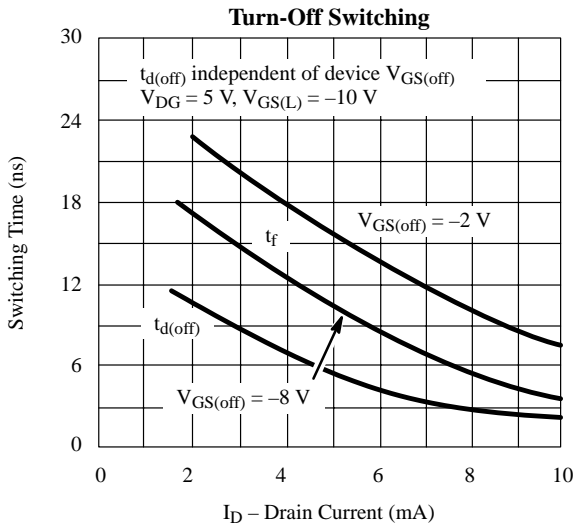
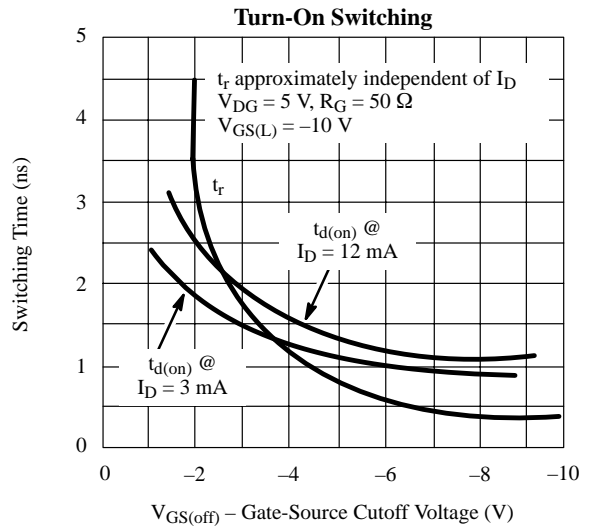
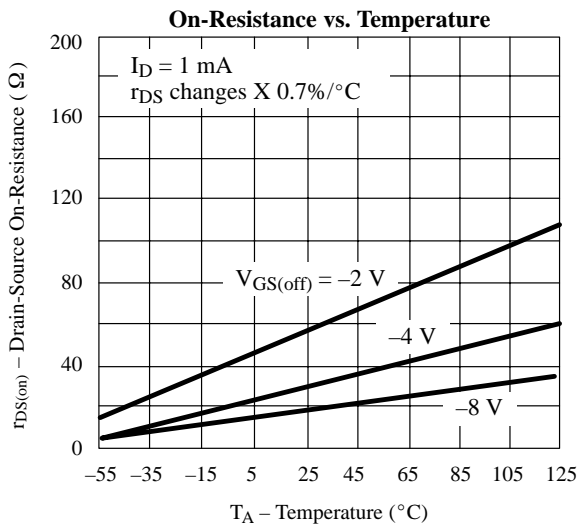
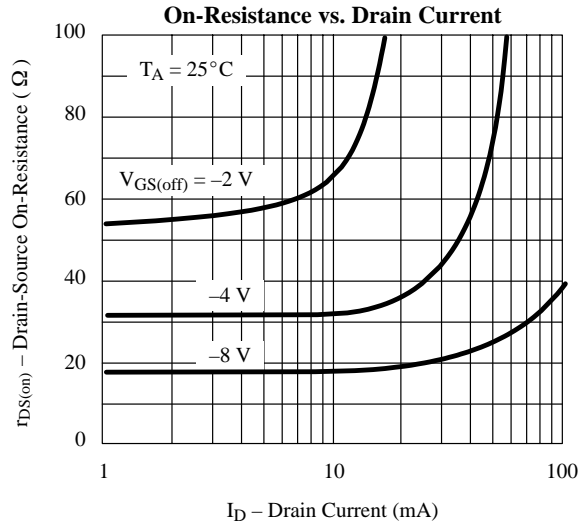
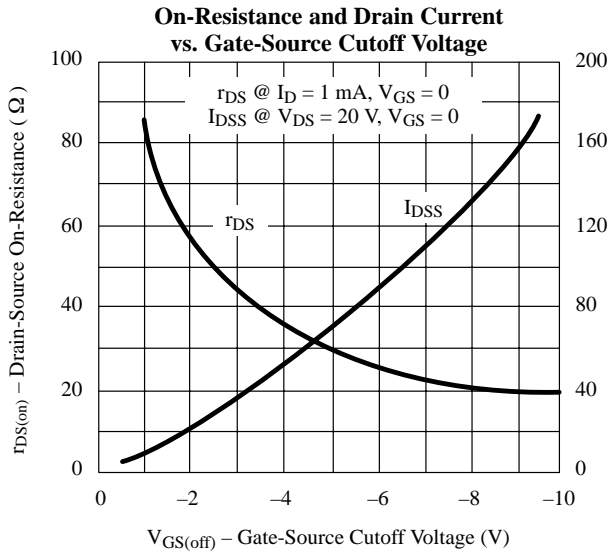

2N4856A/4857A/4858A

Typical Characteristics (Cont'd)

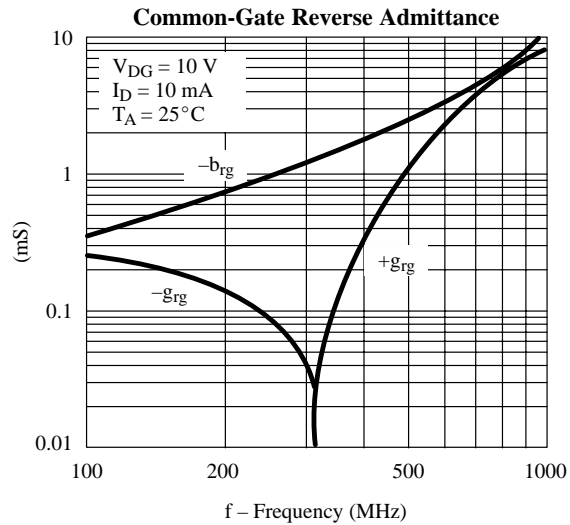
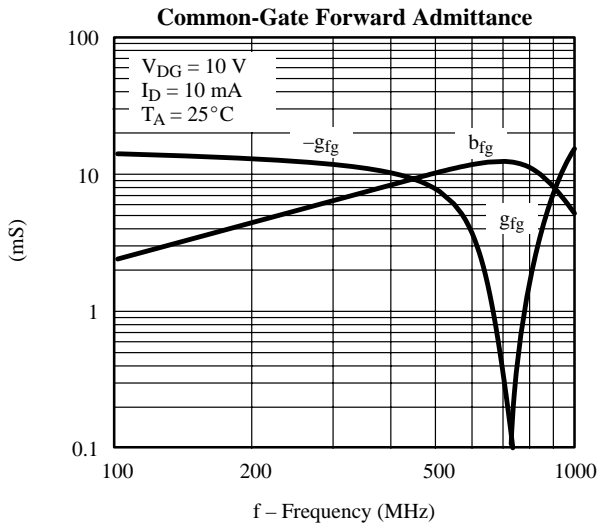
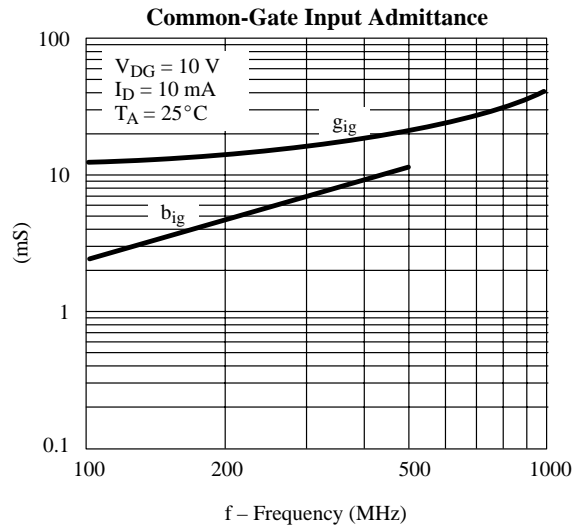
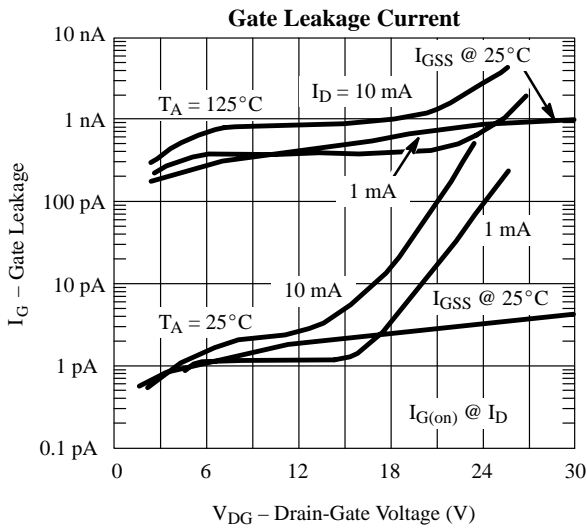
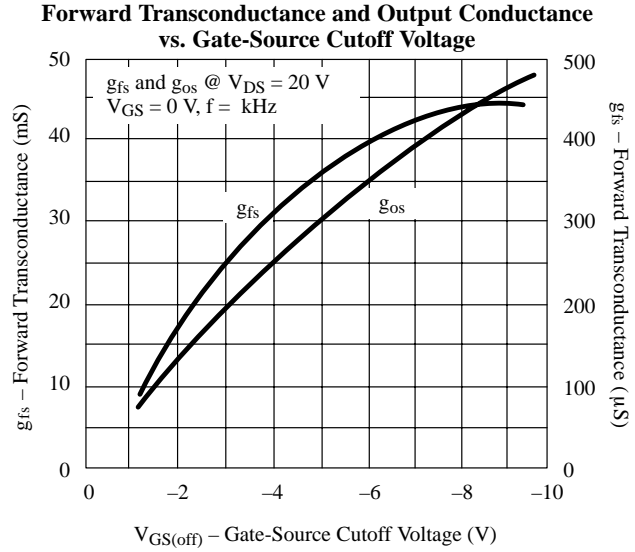
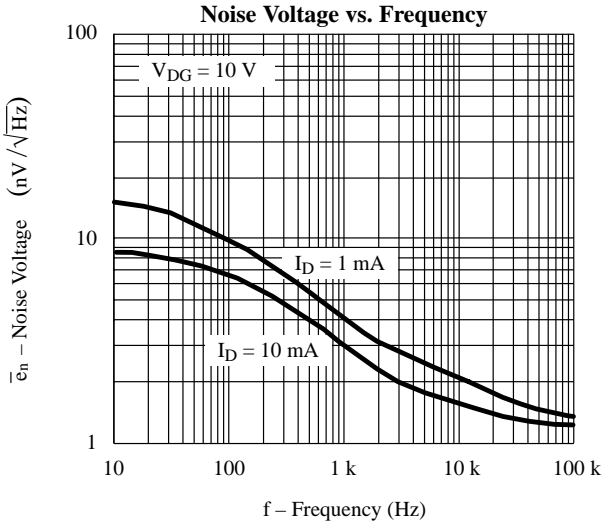

2N4856A/4857A/4858A

Typical Characteristics (Cont'd)

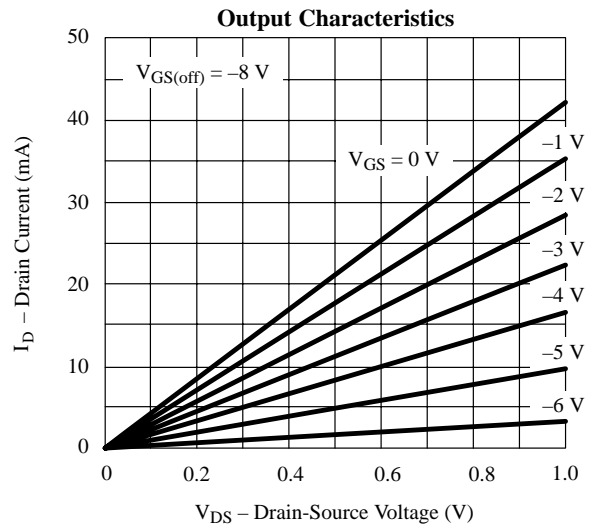
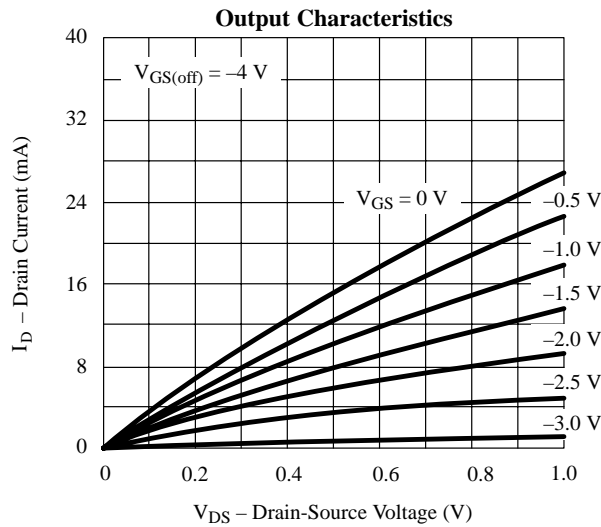
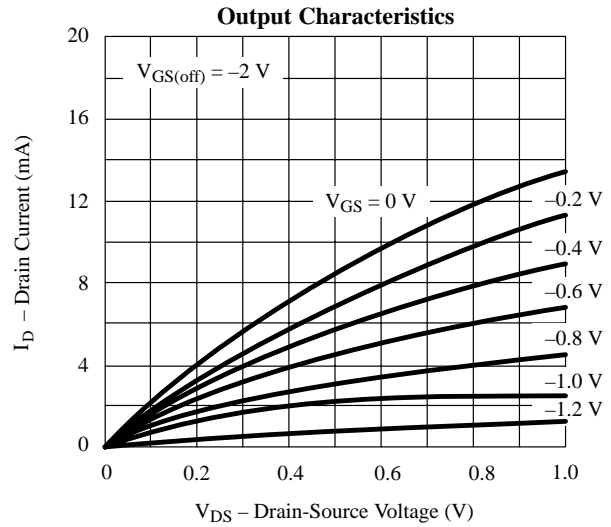
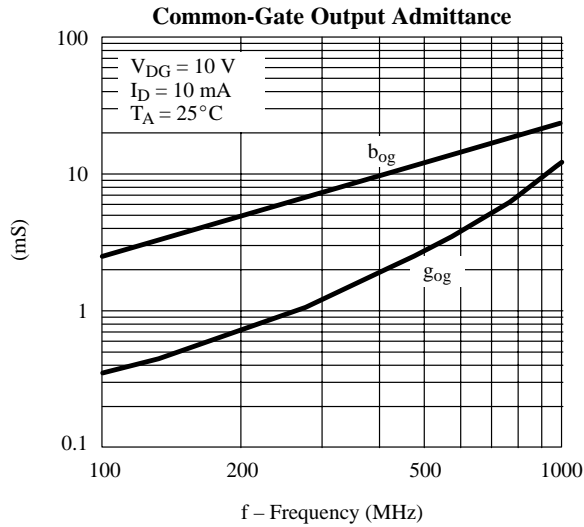

Switching Time Test Circuit

	2N4856A	2N4857A	2N4858A
$V_{GS(L)}$	-10 V	-6 V	-4 V
R_L^*	464 Ω	953 Ω	1910 Ω
$I_{D(on)}$	20 mA	10 mA	5 mA

*Non-inductive

Input Pulse

Rise Time < 1 ns
 Fall Time < 1 ns
 Pulse Width 100 ns
 PRF 1 MHz

Sampling Scope

Rise Time 0.4 ns
 Input Resistance 10 M Ω
 Input Capacitance 1.5 pF

